

## NO<sub>x</sub> REMOVAL FROM AIR BY *NITROSOMONAS EUROPAEA*

G. M. R. Islam<sup>1\*</sup> and M. J. B. Alam<sup>2</sup>

<sup>1</sup>Department of Tea Technology, Shahjalal University of Science and Technology, Sylhet, Bangladesh, and <sup>2</sup>Department of Civil and Environmental Engineering, Shahjalal University of Science and Technology, Sylhet, Bangladesh

Received May 2006, accepted September 2006

Communicated by Prof. Dr. M. A. Hafeez

**Abstract:** Biological air pollution control (APC) technology is now used for control of air pollution as an attractive technology for pollution prevention by treating and recycling air streams from manufacturing operations in a closed system. The aim of the study was to identify a potential immobilization material in the biofilter, which could do the adsorption of NO<sub>2</sub> gas effectively and possess good bacterial immobilization capacity. *Nitrosomonas europaea* is useful for removal of ammonium gas from air by wood charcoal packed biofilter. An experiment with *Nitrosomonas europaea*, in anaerobic environment, indicated that nitrate concentration above 300 mg/L inhibits the microbe. *Nitrosomonas europaea* reactor used for the treatment of nitrate can work within a range of 100 to 500 mg/L without any inhibition. The column was able to remove NO<sub>2</sub> completely and the effluent NO<sub>2</sub> concentration became non-detectable.

**Keywords:** *Nitrosomonas europaea*, nitrate, biofiltration

### Introduction

Nitrogen oxides can adversely affect human health and be detrimental to the environment. Waste gases that contain volatile organic compounds (VOCs) are facing increasingly stringent environmental regulations all over the world, raising the need for efficient treatment methods. Besides being odorous, VOCs are responsible for the production of pollutants known as photochemical oxidants, principally ozone. These compounds could be toxic to humans, damage crops, and are implicated in the formation of acid rain [1].

Odour is a serious cause of community annoyance and a problem that increases with greater public awareness of the quality of the environment and possible control measures [2]. With growing proportion of the world's population living in urban areas and residential and commercial developments being constructed

ever closer to municipal or industrial facility boundaries, odour problems will likely increase in the future [3,4]. There is a range of different sources that could cause the nuisance, for instance traffic, restaurants, farming, industrial and public operations such as pulp mills, wastewater treatment, and composting [5,6].

In order to control VOCs as well as odours emitting from industries (Table 1), biofilters are being used now a days instead of chemical complex absorption method. Biofiltration is a complex process with many physical, chemical, and biological phenomena [7]. The use of heterotrophic organisms (organisms requiring organic carbon as an energy and carbon source) has already been demonstrated where during the infiltration process contaminated gases are passed through the reactor and pollutants are transported into the biofilm. Here, the gases are utilized by microbes as carbon source, energy source or both. Through oxidative reactions, the

\* Corresponding author:

G. M. Rabiul Islam, Department of Tea Technology, Shahjalal University of Science and Technology, Sylhet, Bangladesh.  
E-mail: rabi-ttc@sust.edu, rabi14@yahoo.com

organic contaminants are converted to odourless compounds, such as carbon dioxide, water vapour, and organic biomass. When degrading inorganic compounds, such as hydrogen sulphide, autotrophic bacteria utilize carbon dioxide as a carbon source resulting in the production of new biomass and sulphate or elemental sulphur. The actual biochemical reactions involved are very complex. [8,9,10,11,12,13,14]. At present, major use of biofilters is limited to European countries for air pollution, odor and VOC control, where these have been described as Best Available Control Technology (BACT) [15]. India, one of the most industrialized and hence one of the much polluted nations in the world, has already started showing its concern towards control of toxic emissions in the air [16]. Biofilters offer two major advantages to an energy-starved country like India. Their power consumption is very low (1.8 to 2.5 Kwh/1000m<sup>3</sup>) as compared to the other APC Technologies. Secondly, their capital operating costs are very low which can be an added boon in our industries, which opt for very economic pollution control technologies [17].

Several typical biofilter operating conditions (Table 2) are commonly used to efficiently control inorganic toxicants such as H<sub>2</sub>S, SO<sub>2</sub> [20] (emitted from refineries), NH<sub>3</sub> emissions from fertilizer plants, odors from sugar industry, distilleries, breweries, and such organic carcinogens as benzene, formaldehyde, methylene chloride [19]. Thus, biofilters can be a profitable device, which can offer Bangladesh a clean environment in the 21<sup>st</sup> century. A number of extensive reviews and studies regarding the development and technical aspects of biofiltration have been published in the past decade [21,22,23,24,25,26,27,28,29]. Additionally, much effort has been made for developing models to predict biofilter performance under various conditions [30,31,32,33,34, 35,36]. The major limiting constraints of biofilter applications have been the large space requirements and frequent media replacements as a result of deterioration

or ageing [37]. From this point of view, the present study was conducted to develop a user friendly and economical system for the removal of NO<sub>2</sub> from industrial sources.

**Table 1.** Applications of biofilter [7].

VOC Abatement Applications	Odor Abatement Applications
<ul style="list-style-type: none"> <li>♦ Chemical and Petrochemical Industry</li> <li>♦ Oil and Gas industry</li> <li>♦ Synthetic Resins</li> <li>♦ Paint and Ink</li> <li>♦ Pharmaceutical Industry</li> <li>♦ Waste and Wastewater Treatment</li> <li>♦ Soil and Groundwater Remediation</li> </ul>	<ul style="list-style-type: none"> <li>♦ Sewage Treatment</li> <li>♦ Slaughter Houses</li> <li>♦ Rendering Plants</li> <li>♦ Gelatin and Glue Plants</li> <li>♦ Agricultural and Meat Processing</li> <li>♦ Tobacco, Cocoa and Sugar Industry</li> <li>♦ Flavor and Fragrance</li> </ul>

**Table 2.** Typical biofilter operating conditions for waste air treatment [8].

Parameters	Typical values
Biofilter layer height	1 to 1.5 m
Biofilter area	1 to 300 m <sup>2</sup>
Waste air flow	50 to 300,000 m <sup>3</sup> /h
Biofilter surface loading	5 to 500 m <sup>3</sup> /m <sup>2</sup> .h
Biofilter volumetric loading	5 to 500 m <sup>3</sup> /m <sup>3</sup> .h
Bed void volume	50 %
Mean effective gas residence time	15 to 60 sec.
Operating temperature	15 to 30 °C
pH of support material	6 to 8
Typical removal efficiencies	60 to 100 %
Water content of support material	60 % by mass
Inlet air relative humidity	98 %

## Materials and Methods

The reactor was packed with wood charcoal having size 0.8-1.0. The biofilter was made of plexiglass with 10 cm dia and 100 cm depth. The gas generator consisted of a closed bottle of capacity 5L having an opening at the top (Fig.1). The bottle was first filled with NH<sub>4</sub>C and heated at 60-70<sup>o</sup> C.

The experiment was conducted in two experimental phases. In first phase, the characteristics of *Nitrosomonas europaea* in anaerobic environment in the presence of nitrate were found out. In the second phase, the potentiality of immobilization material in the biofilter, which could adsorb NO<sub>2</sub> gas effectively as well as possess good bacterial immobilization capacity was identified.

**Table 3.** Set up of the experiment.

Parameters	Typical values
Biofilter layer height	120 cm
Biofilter area	170 m <sup>2</sup>
Waste air flow	50 to 300,000 m <sup>3</sup> /h
Biofilter surface loading	5 to 500 m <sup>3</sup> /m <sup>2</sup> .h
Biofilter volumetric loading	5 to 500 m <sup>3</sup> /m <sup>3</sup> .h
Bed void volume	50 %
Mean effective gas residence time	15 to 60 sec.
Operating temperature	15 to 30 °C
pH of support material	6 to 8
Typical removal efficiencies	60 to 100 %

### Immobilization Procedure

*Nitrosomonas europaea* in 100ml of ammonia nutrient media was harvested by centrifugation and then washed three times with sterile 4% Na-alginate solution. The Na-alginate solution containing the cells was dropped into a 4% CaCl<sub>2</sub> solution using a syringe. It immediately formed 3 mm diameter immobilized beads. These beads were activated by flashing with sterile buffer solution for 5 hr. The initial concentration of the biomass was 10,000 CFU/g-dry bead.

### Statistical analysis

Difference between the means under the four different nitrate concentrations, both in the presence of nitrate and NO<sub>2</sub> were analyzed using one way ANOVA and the analysis was carried out using the statistical package SPSS.

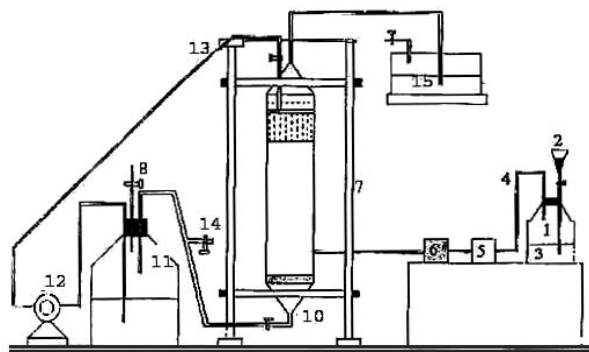

**Figure 1.** Schematic of Biofilter. 1= NO<sub>x</sub> generator bottle; 2= Funnel; 3= Chemicals (HNO<sub>3</sub> + Cu); 4= Connected pipe; 5= Support; 6= Flow rate measurement meter; 8= Support; 9= Waste collector bottle; 10= Upper part of biofilter; 11= Lower part of bio-filter; 12= Pipe; 13= Pump for recycle of waste; 14= Pipe; 15= Pipe; 16= Gas collection for measurement.

## Results and Discussion

### Growth kinetics of *Nitrosomonas europaea* in anaerobic environment in presence of nitrate

*Nitrosomonas europaea* showed three phases of bacterial growth lag, log and stationary phase (Fig. 2). Initially, there was no increment in biomass concentration over time since the bacterium came to a new environment and took time to grow in the presence of nitrate. In the log phase, the biomass increased time-dependently. After some time (in stationary phase) there was no further increment in the biomass as there was no further substrate available for the bacterium. In other words, the bacterial growth rate and the decay rate became almost the same in this phase. The specific growth “μ” increased till the nitrate concentration reached 300 mg/L. Later, “μ” value reduced drastically. This shows that high nitrate concentration may be inhibitory for anaerobic bacteria. Lalan [20] conducted an experiment with sulphate and showed that the concentration of biomass increases with increase in the concentration of sulphate up to 2000 mg/L. They noted that further increase in sulphate concentration drastically decreases the growth rate, and the specific growth rate increases up to 300 mg/L (P < 0.05) of sulphate [20]. Chan *et al.* [38] have shown that the exponential growth phase for *Bacillus* sp during a period of 3 to 8 days (with generation times of 9 to 33 h) is followed by slower growth, and after a stationary phase of 25 to 40 days, the bacterial number starts to decrease, probably due to substrate and/or oxygen depletion, or unfavorable pH.

**Table 4.** Specific growth rate of *Nitrosomonas europaea* at different nitrate concentration.

Nitrate conc. (mg/L)	100	200	300	400	500
<i>i</i> (h <sup>-1</sup> )	0.0375	0.0455	0.0481	0.0098	0.0118

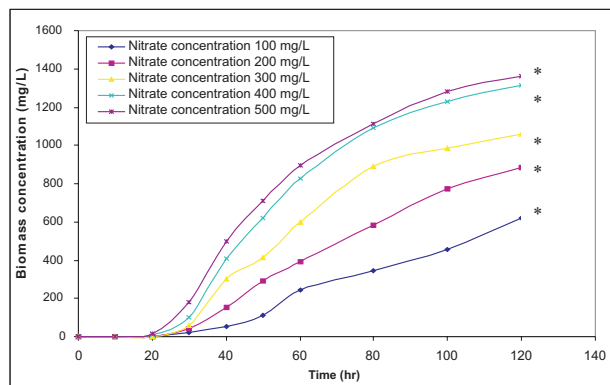

**Figure 2.** Growth curve of *Nitrosomonas europaea* in presence of nitrate. Values represent mean  $\pm$  SE of three replication. \*  $P < 0.05$ .

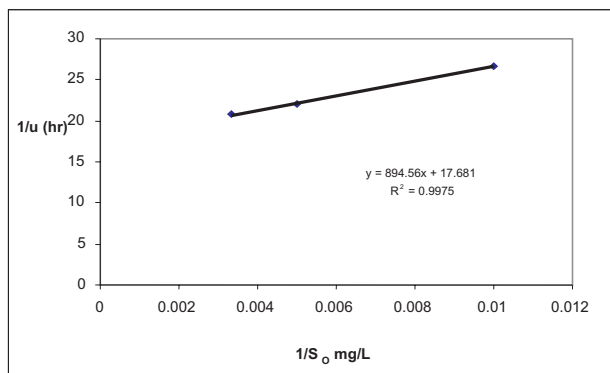

**Figure 3.** Maximum specific growth rate for *Nitrosomonas europaea*.

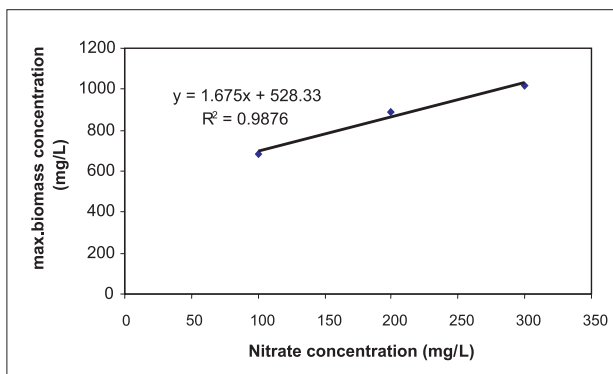

**Figure 4.** *Nitrosomonas europaea* growth yield curve in the presence of nitrate.

Maximum specific growth rate of  $0.0565 \text{ h}^{-1}$  was obtained for *Nitrosomonas europaea* in anaerobic environment using nitrate as electron acceptor (Fig. 3). The slope of the graph between maximum concentration of biomass and nitrate concentration gave growth yield (yield coefficient) for the bacterium (Fig. 4). The growth

yield of *Nitrosomonas europaea* using nitrate as electron acceptor was found to be 1.67.

### Growth kinetics of *Nitrosomonas europaea* in anaerobic environment in presence of Nitrogen dioxide

There were again three distinct phases i.e. lag, log and stationary (Fig. 5) in the growth of *Nitrosomonas europaea* in anaerobic environment in the presence of  $\text{NO}_2$ . The biomass increased with increase in the concentration of  $\text{NO}_2$  up to 500 mg/L ( $P < 0.05$ ).

**Table 5.** Specific growth rate of *Nitrosomonas europaea* in the presence of different  $\text{NO}_2$  concentrations.

$\text{NO}_2$ conc, (mg/L)	100	200	300	400	500
$\mu$ ( $\text{h}^{-1}$ )	0.0402	0.0472	0.051	0.038	0.029

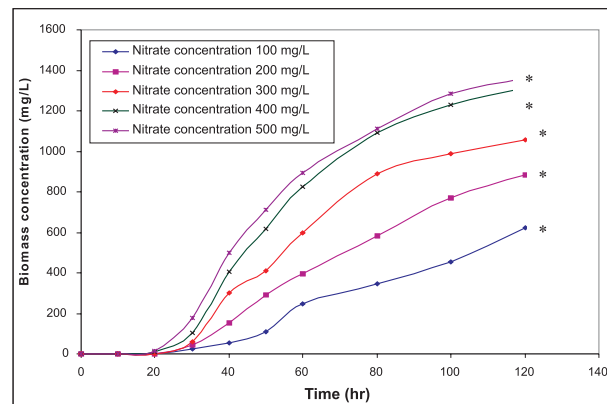

**Figure 5.** Growth curve of *Nitrosomonas europaea* in presence of nitrogen dioxide. Values represent mean  $\pm$  SE of three replication. \*  $P < 0.05$ .

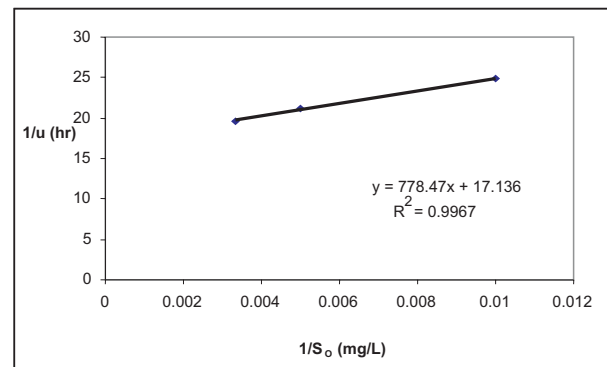

**Figure 6.** Maximum specific growth rate for *Nitrosomonas europaea* in presence of nitrogen dioxide.

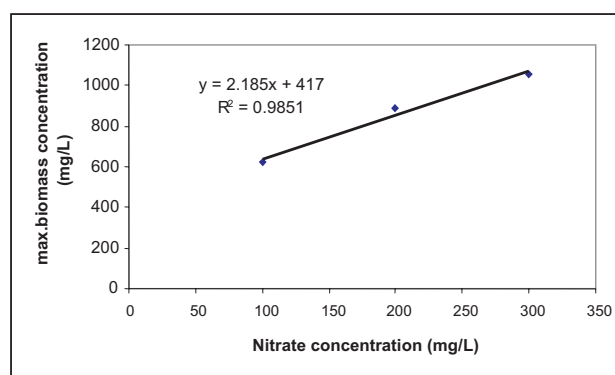

**Figure 7.** Growth yield for *Nitrosomonas europaea* in presence of nitrogen dioxide.

Maximum specific growth rate of  $0.0584\text{h}^{-1}$  was obtained for *Nitrosomonas europaea* in the anaerobic environment using  $\text{NO}_2$  as electron acceptor (Fig. 6). The slope of the graph between maximum concentrations of biomass and  $\text{NO}_2$  concentration gave growth yield (yield coefficient) for the bacterium (Fig. 7). The growth yield of *Nitrosomonas europaea* using nitrate as electron acceptor was found to be 1.68. According to Otten *et al.* [39], biofiltration of butyric acid is possible. According to them over 97% of the total removal is accomplished at the upper layers. They also reported that bacterial growth has a relationship with temperature and loading rate i.e. loading rate has an influence on removal efficiency.

## Conclusions

- Nitrate concentration above 300 mg/lit in anaerobic environment causes inhibition to *Nitrosomonas europaea*.
- Any *Nitrosomonas Europaea* reactor used for the treatment of  $\text{NO}_x$  can work within a range of 100 to 500 mg/L and the effluent  $\text{NO}_2$  becomes non-detectable.

## References

1. Van Langenhove, H., Wuyts, E. and Schamp, N. 1986. Elimination of hydrogen sulphide from odorous air by a wood bark biofilter. *Water Res.* 20:1471-1476.
2. Vincent, A. and Hobson, J. 1998. *Odour Control, CIWEM Monographs on Best Practice No. 2.* Terence Dalton Publishers, London.
3. Gostelow, P., Parsons, S.A. and Stuetz, R.M. 2001. Odour measurements for sewage treatment works *Water Res.* 35:579-597.
4. Longhurst, P.J., Cotter, M. and Gostelow, P. 2004. Odour management plans: a risk-based approach using stakeholder data. *Waste Sci. Tech.* 50:7-23.
5. Stuetz, R. and Frechen, F.-B. 2001. *Odours in wastewater treatment measurement, modeling and control.* IWA Publishing, London, pp 437.
6. Zolghadr, M., Rupke, M. and Rix, M. 2004. Community involvement and participation--City of Toronto--Ashbridges Bay treatment plant odor impact assessment and control. In: *Proceedings of the WEF/A&WMA Odors and Air Emissions.* Bellevue, Washington, USA.
7. Devinny, J.S., Deshusses, M.A. and Webster, T.S. 1999. *Biofiltration for air pollution control.* Lewis Publishers. New York.
8. Apel, W.A. and Turick, C.E. 1993. The use of denitrifying bacteria for the removal of nitrogen oxides from combustion gases. *Fuel* 72:1715-1718.
9. Apel, W.A., Barnes, J. and Barrett, K. 1995. *Biofiltration of nitric oxide from fuel combustion gas streams.* Proceedings of Air Waste Manag. Assoc., 88th Annual Meeting and Exhibition. San Antonio, Texas, June 18-23.
10. Barnes, J.M., Apel, W.A. and Barrett, K.B. 1994. Removal of nitrogen oxides from gas streams using biofiltration. *J. Haz. Material* 41:315-326.
11. du Plessis, C.A., Kinney, K.A., Schroeder, E.D., Chang, D.P.Y. and Scow, K.M. 1998. Denitrification and nitric oxide reduction in an aerobic toluene-treating biofilter.

- Biotech. Bioengg.* 58:408-415.
12. **Lee, B., Apel, W.A. and Smith, W.** 1999. *Effect of oxygen on thermophilic denitrifying populations in biofilters treating nitric oxide containing off-gas streams*. Paper # 99-322 CD-ROM Proc. Air and Waste Management Association, 92nd Annual Meeting and Exhibition. St.Louis, Missouri, June 20-24.
  13. **Woertz, J.R., Kinney, K.A., McIntosh, N.D. and Szaniszlo, P.P.J.** 1999. *Removal of nitric oxide in a fungal vapor-phase bioreactor*. Paper #99-297, CD-ROM, Proc. Air and Waste Management Association's 92nd Annual Meeting and Exhibition. St. Louis, Missouri, June 20-24.
  14. **Chou, M. and Lin, J.** 2000. Biotrickling filtration of nitric oxide. *J. Air Waste Manag. Assoc.* 50:502-508.
  15. **Swedish Environmental Protection Agency (SEPA).** 1991. *Strategy for volatile organic compounds (VOC). Emissions, effects, control measures*. Solna: Swedish EPA, pp 105.
  16. **Pandey, R.A. and Malhotra. S.** 1999. Desulfurisation of gaseous fuels with recovery of elemental sulfur: An overview. In: *Critical Reviews in Environmental Science and Technology*. Ed. Mondol, M., pp.156-178, National Environmental Engineering Research Institute, Nagpur, India.
  17. **James, G.C. and Natalie S.** 1996. *Microbiology (A Laboratory Manual)*. The Benjamin/Cummings Publishing Co., India. pp. 96-122.
  18. **Michel, J.P., Chan, J.E.C.S and Noel, K.R.** 1993. *Microbiology--Concepts and Applications*. McGraw-Hill, London. pp. 67-87.
  19. **Iranpour, R., Cox, H.H.J., Deshusses, M.A. and Schroeder, E.D.** 2005. Literature review of air pollution control biofilters and biotrickling filters for odor and volatile organic compound removal. *Environ. Progress* 24:254-267.
  20. **Lalan. S.** 2000. *Removal of SO<sub>x</sub> by biofilter*. M.Sc Engg. Thesis, Indian Institute of Technology, Kharagpur, India.
  21. **Easter, C., Quigley, C., Burrowes, P., Witherspoon, J. and Apgar, D.** 2005. Odor and air emissions control using biotechnology for both collection and wastewater treatment systems. *Chem. Engg. J.* 113:93-104.
  22. **Ergas, S.J. and Cardenaz-Gonzales, B.** 2004. "Biofiltration: past, present and future directions." *BioCycle* 45:35-39.
  23. **Kennes, C. and Thalasso, F.** 1998. Waste gas biotreatment technology. *J. Chem. Tech. Biot.* 72:303-319.
  24. **Leson, G. and Winer, A.W.** 1991. Biofiltration: an innovative air pollution control technology for VOC emissions. *J. Air Waste Manag. Assoc.* 41:1045-1054.
  25. **McNevin, D. and Barford, J.** 2000. "Biofiltration as an odour abatement strategy." *Biochem. Engg. J.* 5: 231-242.
  26. **Swanson, W.J. and Loehr, R.C.** 1997. Biofiltration: fundamentals, design and operations principles, and applications. *ASCE J. Environ. Engg.* 123:538-546.
  27. **Van Lith, C., Leson, G. and Michelsen, R.** 1997. Evaluating design options for biofilters. *J. Air Waste Manag. Assoc.* 47:37-48.
  28. **Wani, A.H., Branion, R.M.R. and Lau, A.K.** 1997. Biofiltration: a promising and cost-effective control technology for odors, VOCs and air toxics. *Environ. Sci. Health* 32:2027-2055.
  29. **Deshusses, M.A., Hamer, G. and Dunn, I.J.** 1995. Behavior of biofilters for waste air biotreatment. 1. Dynamic model development. *Environ. Sci. Tech.* 29:1048-1058.
  30. **Hodge, D.S. and Devlinny, J.S.** 1995. Modeling removal of air contaminants by biofiltration. *ASCE J. Environ. Engg.* 121:21-32.

31. **Jorio, H., Payre, G. and Heitz, M.** 2000. Mathematical modeling of gas-phase biofilter performance. *J. Chem. Tech. Biotech.* 78:834-846.
32. **Li, H., Crittenden, J.C., Mihelcic, J.R. and Hautakangas, H.** 2002. Optimization of biofiltration for odor control: model development and parameter sensitivity. *Water Environ. Res.* 74:5-16.
33. **Ottengraf, S.P.P., and van der Oever, A.H.C.** 1983. Kinetics of organic compound removal from waste gases with a biological filter. *Biotech. Bioengg.* 25: 3089-3102.
34. **Shareefdeen, Z., Baltzis, B.C., Oh, Y.S. and Bartha, R.** 1993. Biofiltration of methanol vapor. *Biotech. Bioengg.* 41:512-524.
35. **Streese, J., Schlegelmilch, M., Heining, K. and Stegmann, R.** 2005. A macrokinetic model for dimensioning of biofilters for VOC and odour treatment. *Waste Manag.* 25:965-974.
36. **Zarook, S.M. and Shaikh, A.A.** 1997. Analysis and comparison of biofilter models. *Chem. Engg. J.* 65:55-61.
37. **Shareefdeen, Z.** 2002. Removing volatile organic compound (VOC) emissions from a printed circuit board manufacturing facility using pilot and commercial-scale biofilters. *Environ. Progress* 21:196-201.
38. **Chung, Y.C., Huang, C.P., Pan, J.R. and Tseng, C.P.** 1998. Comparison of autotrophic and mixotrophic biofilters for H<sub>2</sub>S removal. *ASCE J. Environ. Engg.* 124:362-367.
39. **Otten, L., Afzalm, M.T. and Mainville, D.M.** 2004. Biofiltration of odors: laboratory studies using butyric acid. *Adv. Environ. Res.* 8:397-409.